

# electriQ

## USER MANUAL

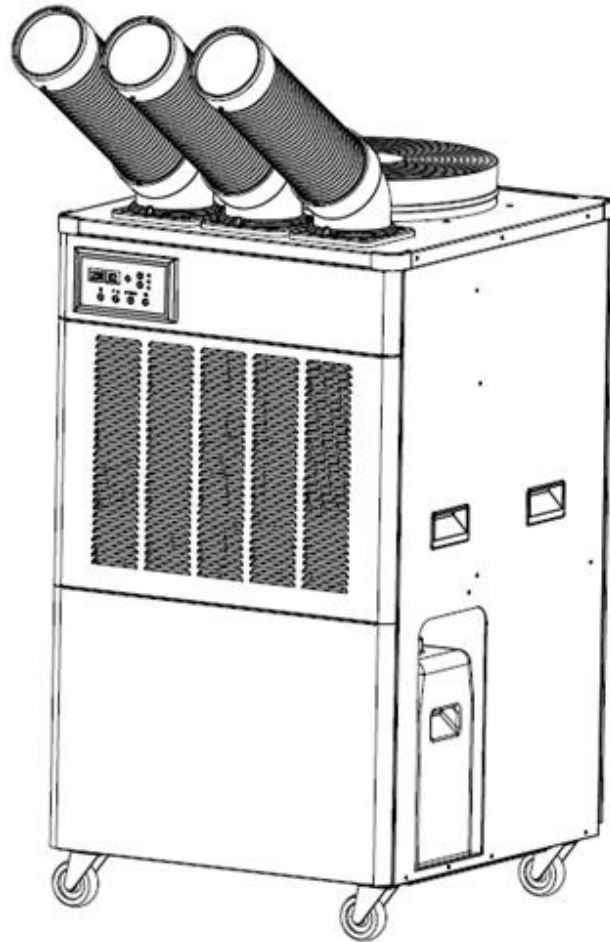

## **electriQ 18,000 BTU PORTABLE INDUSTRIAL AIR CONDITIONER CMAC20M**

Thank you for choosing electriQ

Please read this user manual before using this innovative Air Conditioner and keep it safe for future reference.

Visit our page [www.electriQ.co.uk](http://www.electriQ.co.uk) for our entire range of Intelligent Electricals

## CONTENTS

SAFETY INFORMATION	3
FEATURES	5
APPLIANCE DIAGRAM	5
INSTALLATION	6
OPERATION	7
EMPTYING THE INTERNAL WATER TANK	9
CLEANING AND MAINTENANCE	9
TROUBLESHOOTING	10
SUPPORT	11
TECHNICAL SPECIFICATION	11

## SAFETY INSTRUCTIONS



### Important!

- Carefully read the instructions before operating the unit
- This appliance is for indoor use only.
- Rating: This unit must be only connected to a 220-240 V / 50 Hz earthed outlet.
- Installation must be in accordance with regulations of the country where the unit is used.
- If you are in any doubt about the suitability of your electrical supply have it checked and, if necessary, modified by a qualified electrician.
- This air conditioner has been tested and is safe to use. However, as with any electrical appliance - use it with care.
- Disconnect the power from the appliance before dismantling, assembling or cleaning.
- Avoid touching any moving parts of the appliance.
- Never insert fingers, pencils or any other objects through the guard.
- This appliance is not intended for use by persons (including children) with reduced physical, sensory or mental capabilities. It is also not intended for use by those with a lack of experience and knowledge, unless they have been given supervision or instruction concerning the use of the appliance by a person responsible for their safety.
- Do not leave children unsupervised with this appliance.
- Do not clean the unit by spraying it or immersing it in water.
- Never connect the unit to an electrical outlet using an extension cord. If an outlet is not available, one should be installed by a qualified electrician.
- Never operate this appliance if the cord or plug is damaged. Ensure the power cord is not stretched or exposed to sharp objects/edges.
- A damaged supply cord should be replaced by the manufacturer or a qualified electrician in order to avoid a hazard.
- Any service other than regular cleaning or filter replacement should be performed by an authorised service representative. Failure to comply could result in a voided warranty.
- Do not use the appliance for any purpose other than its intended use.
- **The air conditioner unit must always be stored and transported upright, otherwise irreparable damage may be caused to the compressor; if in doubt we suggest waiting at least 24 hours before starting the unit.**
- Do not move the air conditioner while it is operating. When operating the castors should be locked in position.
- Ensure the unit is positioned so that it is on a flat level surface, and does not cause an obstruction to walkways.
- This air conditioner is not designed to be used on boats, or any other type of transportation.
- Avoid restarting the air conditioning unit unless 3 minutes have passed since being turned off. This prevents damage to the compressor.

- Never use the mains plug as a switch to start and turn off the air conditioning unit. Use the provided ON/OFF button located on the control panel.
- Always place the unit on a dry and stable surface.
- The appliance should not be installed in laundry or wet rooms.
- The appliance must be placed in a room without sources of ignition (for example: open flames, an operating gas appliance or an operating electric heater).
- R1234yf refrigerant gas complies with European environmental directives.
- R1234yf has a low GWP (Global Warming Potential) of 4.
- The air conditioners contain around 950 g of R1234yf refrigerant gas.
- Do not use or store in an unventilated space with an area smaller than 6 m<sup>2</sup> per unit.
- The room must be such as to prevent stagnation of possible leaks of refrigerant gas as there could be a danger of fire or explosion should the refrigerant come into contact with electric heaters, stoves or other sources of ignition.
- Refrigerant gas may be odourless.
- Do not use the product and contact the retailer for advice, if damage has occurred to the unit which may have compromised the refrigerant system.
- Any repairs or maintenance must only be carried out on the unit by a suitably qualified engineer. Before opening and servicing the unit the authorised engineer must be in possession of a copy of the manufacturer's service manual and must follow the safety information contained within it to ensure all hazards are minimized.
- The refrigerant system should not be perforated or punctured.

### **Energy Saving and Unit Safety Protection Tips**

- Do not cover or restrict the airflow from the air outlet or inlet.
- For maximum performance the minimum distance from a wall or objects should be 50cm.
- Keep the filters clean. Under normal conditions, filters should only need cleaning once every three weeks (approximately). Since the filters remove airborne particles, more frequent cleaning may be necessary, depending on the air quality.
- For the initial start-up set the fan speed to maximum and the thermostat to 5 degrees lower than the current temperature. After, set the fan switch to low and set the thermostat to your desired setting.
- To protect the unit, we recommend not using the cooling function when the ambient temperature is higher than 45°C or lower than 18°C.

## FEATURES

- 3 in 1 Cooling, Fan, Dehumidifier.
- 2 speed fan: Balancing quiet operation with performance.
- 24 Hours Start / Stop Timer.
- Digital Thermostat.
- Auto-Restart to retain the settings in the event of power failure.
- Castors for Enhanced Portability.
- Durable metal casing.
- Triple cold air ducts allowing distribution of the cold air.

## HOSE SPECIFICATIONS

Hose	Hose External Diameter (mm)	Supplied Hose Length	Max Permitted Hose Length (cm)
Cold Air	120	37	200
Hot Air	380	<b>NOT SUPPLIED</b>	300

## APPLIANCE DIAGRAM

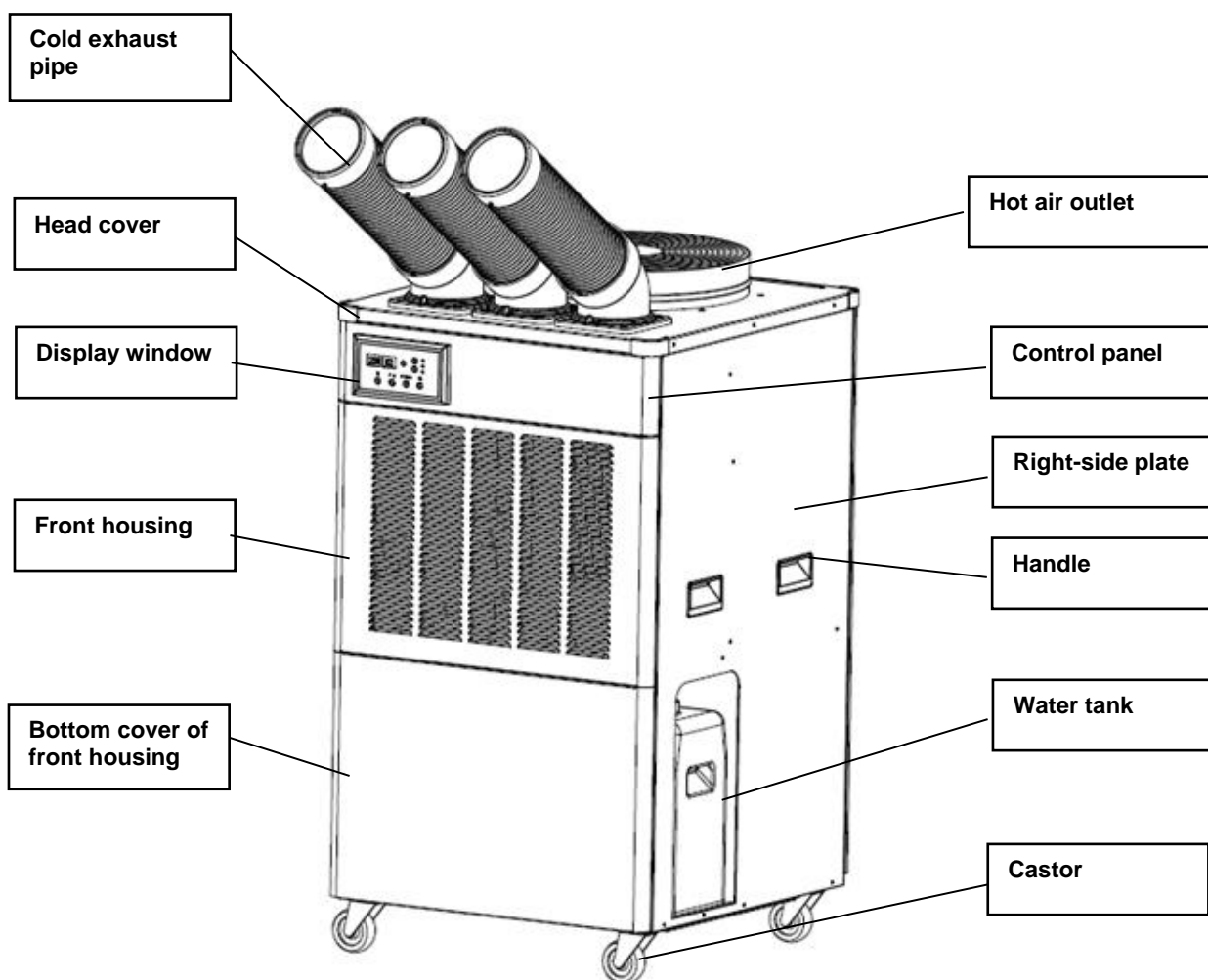

# INSTALLATION

## COLD AIR OUTLETS

1. Line up the dimple on the Elbow with the notch on the Hose connector on the top of the air conditioner.
2. Rotate anticlockwise until a click can be heard, indicating the elbow has locked into place.
3. Insert the Cold Air Hose into the Elbow, again lining up the dimple with the notch in the Elbow.
4. Rotate the pipe anticlockwise to fix it in place.
5. The pipe can then be extended and pointed in the desired direction.
6. Repeat for the second air outlet.

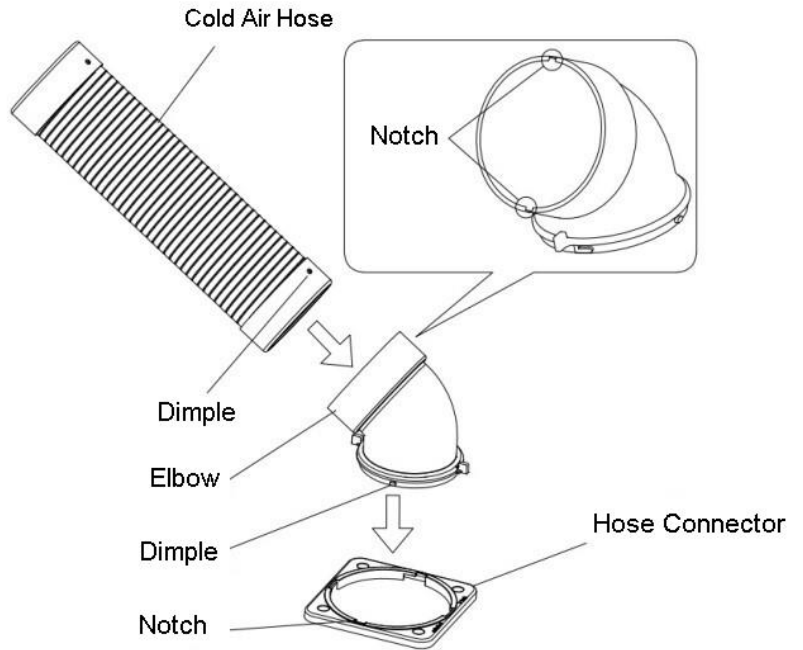

## HOT AIR OUTLET

1. Push the Hot Air Hose onto the Hot air outlet on the top of the appliance.
2. Extend the pipe and route it outside.

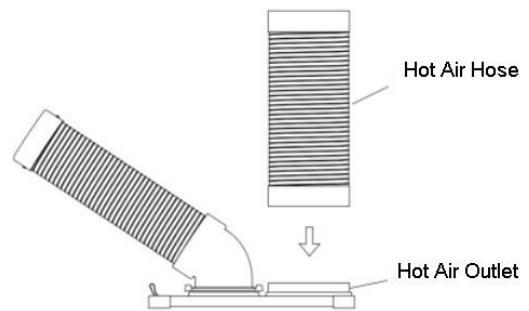

## NOTES:

- The best form of installation is through a wall duct. By properly venting you expel hot air from your room while efficiently cooling it.
- Your air conditioner should be used without the vent pipe in dry mode. When using dry mode ensure that the water tank is monitored and regularly emptied. Permanent plumbing can be also installed for dry mode or an external uplift water pump can be set up for unattended use.





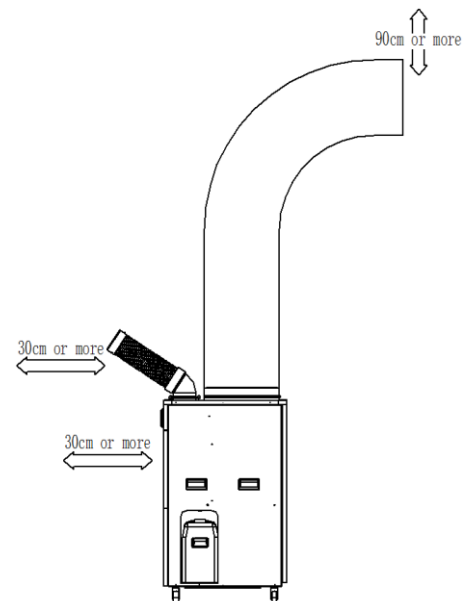



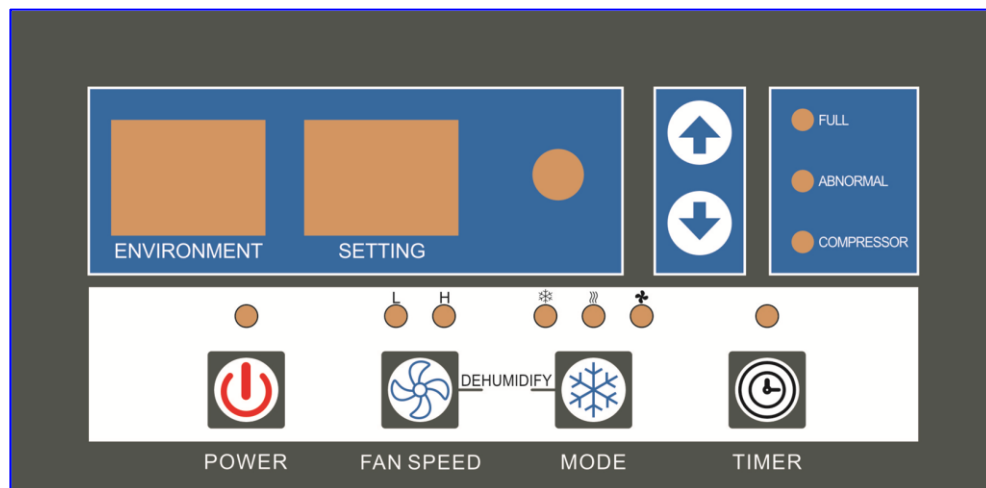





## IMPORTANT SAFEGUARDS

If hoses are extended above the permitted length, the unit may malfunction which can invalidate the warranty. The outlet vent must be well ventilated and not obstructed as this will cause the unit to overheat. Keep the all the hoses as straight and short as possible and avoid bending the air hose by more than 45 degrees in order to maintain the performance of the unit. Excessive bends in the hose may prevent the unit from expelling the hot air, which can lead to internal damage which would invalidate the warranty. Ensure that sufficient space is left in from the end of the vent pipes (30cm – Cold air, 90cm Hot air)







# OPERATION



 <b>POWER</b>	<p>Press the POWER button to turn the unit ON or OFF.</p>						
 <b>MODE</b>	<p>Press the MODE button to cycle between the 3 modes, the indicator for the selected mode will be illuminated.</p> <table border="1" data-bbox="231 913 1477 1323"> <tr> <td data-bbox="231 913 363 1070">             COOL         </td> <td data-bbox="363 913 1477 1070"> <p>The room is cooled with the cold air expelled through the cold air outlets while hot air is expelled through the Hot Air Pipe. The desired room temperature can be set between 15 and 35 degrees using the Up and Down buttons, and the fan speed can be changed using the SPEED button.</p> </td> </tr> <tr> <td data-bbox="231 1070 363 1193">             FAN         </td> <td data-bbox="363 1070 1477 1193"> <p>The fan speed can be changed pressing the SPEED button.</p> </td> </tr> <tr> <td data-bbox="231 1193 363 1323">             DRY         </td> <td data-bbox="363 1193 1477 1323"> <p>The unit removes moisture from the air. When using as a dehumidifier the Hot air Pipe should not be used. We advise that continuous drainage is set up when using the Dry mode.</p> </td> </tr> </table>	 COOL	<p>The room is cooled with the cold air expelled through the cold air outlets while hot air is expelled through the Hot Air Pipe. The desired room temperature can be set between 15 and 35 degrees using the Up and Down buttons, and the fan speed can be changed using the SPEED button.</p>	 FAN	<p>The fan speed can be changed pressing the SPEED button.</p>	 DRY	<p>The unit removes moisture from the air. When using as a dehumidifier the Hot air Pipe should not be used. We advise that continuous drainage is set up when using the Dry mode.</p>
 COOL	<p>The room is cooled with the cold air expelled through the cold air outlets while hot air is expelled through the Hot Air Pipe. The desired room temperature can be set between 15 and 35 degrees using the Up and Down buttons, and the fan speed can be changed using the SPEED button.</p>						
 FAN	<p>The fan speed can be changed pressing the SPEED button.</p>						
 DRY	<p>The unit removes moisture from the air. When using as a dehumidifier the Hot air Pipe should not be used. We advise that continuous drainage is set up when using the Dry mode.</p>						
 <b>FAN SPEED</b>	<p>Press the SPEED button to cycle through the two fan speeds. Each time the SPEED button is pressed, the indicator will change to show the currently selected speed. The fan speed can be changed between Low and High.</p>						
 <b>TIMER</b>	<p>The timer functions cannot be combined or repeated.</p> <p><b>POWER ON TIMER</b>          With the appliance in standby, press the TIMER button to set the power-on timer. Use the Up and Down buttons to adjust the duration of the timer (1 to 24 hours). The Timer indicator will turn on and the unit will start after the selected number of hours.</p> <p><b>POWER OFF TIMER</b>          With the appliance running with the desired settings, press the TIMER button to set the power-off timer. Use the Up and Down buttons to adjust the duration of the timer (1 to 24 hours). The timer indicator will illuminate and the unit will stop after selected number of hours.</p>						
	<p>Used to adjust temperature in COOL mode and to set the duration of the TIMER. The buttons are not used in FAN or DRY modes.</p>						

## INDICATORS

	Shows the current room temperature.
	Shows the desired room temperature during cooling Mode. While setting the timer it will display the duration of the timer.
	Will illuminate when the water tank is full, and the unit will stop operating. Remove the water tank, empty it and replace to extinguish the light and re start operation.
	Will illuminate when a fault is detected, such as the room temperature out of the operating range. Unplug the unit and resolve the issue before restarting the unit.
	Will illuminate to show that the compressor is operating to cool the air in Cool and Dry modes.

## MULTI PROTECTIVE FUNCTIONS

### FROST PROTECTION

In COOL, DRY or AUTO modes, if the temperature of the exhaust is too low, the machine will automatically stop operating until the temperature has risen.

### OVERFLOW PROTECTION

When the water in the internal water tank exceeds the warning level, the machine will stop operating and sound an alarm with the LCD display showing "E4". To resume operation empty the internal water tank. After the water is emptied, the machine will automatically return to the original state.

### AUTO-DEFROST

The machine has automatic defrosting function. If during operation the temperature of the internal coils drops too low, the unit will enter auto defrost and the heating symbol will flash on the control panel.

### AUTOMATIC THERMAL PROTECTION

To protect the service life of the machine, the machine has automatic thermal protection. If the temperature within the unit is outside of the specified range, the compressor and the lower motor will stop operation. The appliance will automatically return to normal operation after the temperature of the machine recovers.

### COMPRESSOR PROTECTION

To prevent damage to the compressor there is a 3 minute delay start protection function.



## EMPTYING THE INTERNAL WATER TANK

### MANUAL DRAINAGE:

When the internal water tank is full the unit will stop working.

Shut off the unit and unplug. Try not to move the appliance as this may cause the water in the internal tank to spill out. Remove the water tank from the base of the unit and empty into a sink or drain. Replace the water tank in the unit before plugging back in and restarting operation.

### CONTINUOUS DRAINAGE:

Remove the water tank from the unit, and connect the drainage pipe to the spout. The drain is gravity fed, so can be routed downwards to a suitable drain. Alternatively the pipe can be attached to an external uplift pump (not supplied) to pump the water uphill to a suitable drainage point.

**NOTE:** This model has a self-evaporative function, which reduces the need to empty the water tank. If the unit is vented correctly most of the water is reused to cool the condenser coils and any excess is evaporated. Please do not use continuous drainage if you intend to use the self-evaporating facility.

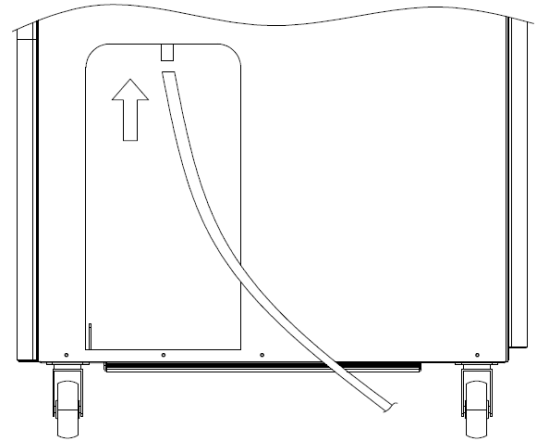

## CLEANING AND MAINTENANCE

**PLEASE TURN OFF THE UNIT AND UNPLUG FROM THE MAINS BEFORE CLEANING OR PERFORMING ANY MAINTENANCE**

### CLEAN THE SURFACE

Clean the surface of the machine with a wet soft cloth. Do not use chemicals, such as benzene, alcohol, gasoline, etc; otherwise, as this may cause damage to the surface and or the internal workings of the machine

### AIR FILTER CLEANING

If the filter screen is clogged with dust, the effectiveness of the air conditioner is reduced. The filter screen should be cleaned once every two weeks or as often as necessarily in your environment.

## END OF SEASON MAINTENANCE

1. Empty the internal water tank.
2. Then switch the unit to low fan mode.
3. Keep the unit in this mode for half day - until the conduit is dried. Doing this helps to keep the inside of the unit dry and prevents mould from developing
4. Turn off the unit and pull out the plug.
5. Empty the water tank again.
6. Coil the wire and bind it together, then put it into the accessories space.
7. Separate the vent pipes and store the, safely.
8. Cover the unit and keep it in a dry place.

## TROUBLESHOOTING

Do not repair or disassemble the air conditioning. Unqualified repair will invalidate the warranty and may lead to failure, causing injuries and property damage. Only use it as directed in this user manual and only perform operations advised here.

Problems	Reasons	Solutions
The air conditioner does not work.	There is no electricity.	Turn it on after connecting it to a socket with electricity.
	FULL indicator is illuminated	Discharge the water inside.
	The ambient temperature is too low or too high	Only use to use the machine within temperature range of 18-45°C
	In cooling mode, the room temperature is lower than the desired temperature	Change the desired temperature.
	In dry mode, the ambient temperature is low.	The ambient temperature must be above 18 °C. (60 °F).
The cooling effect is not good	There is direct sunlight.	Use curtains to reduce the direct sun heat
	Doors or windows are open; there are a lot of people; or in cooling mode, there are other sources of heat (e.g. fridges)	Close doors and windows; increase air conditioning power
	The filter screen is dirty.	Clean or replace the filter screen.
	The air inlet or outlet is blocked.	Clear obstructions; make sure venting is correct as described in this user manual and hose is not bent
Loud Noise	The air conditioning is not placed on a flat surface.	Put the air conditioning on a flat and hard place (to reduce noise).
Compressor does not work.	Overheat protection starts.	Wait for 3 minutes until the temperature is lowered, and then restart the machine.
Others	No refrigerant or there is very little refrigerant	Refer to Service Centre (check leakage, welding, vacuum pump, charge refrigerant according to name plate)
	Anti-freezing protection	Waiting for defrosting. Function will recover automatically. No user input needed.
	High pressure protection	After inside gas pressure comes down, it will function normally. No user input needed
TC	Coil heat exchanger fault	Ensure nothing is restricting the airflow before restarting
CO	Compressor overloading, over current or system high-pressure protection	Cancel the system fault function, recoverable

If problems not listed in the table occur or recommended solutions do not work, please contact the service centre.

## APPENDIX



**Disposal:** Do not dispose this product as unsorted municipal waste. Collection of such waste must be handled separately as special treatment is necessary. Recycling facilities are now available for all customers at which you can deposit your old electrical products. Customers will be able to take any old electrical equipment to participating civic amenity sites run by their local councils. Please remember that this equipment will be further handled during the recycling process, so please be considerate when depositing your equipment. Please contact the local council for details of your local household waste recycling centres.

## electriQ UK SUPPORT

[www.electriQ.co.uk/support](http://www.electriQ.co.uk/support)

Please, for your own convenience, make these simple checks before calling the service line. If the unit still fails to operate call the number below, or complete the online form.

0330 390 3061

1. Has the unit been standing upright for at least 2 hours?
2. Is the unit plugged into the mains?
3. Is the fuse OK?
4. Switch the unit off and wait three minutes to see if the issue is resolved. Restart the unit.
5. Check if the water tank is full.

Office hours: 9AM - 5PM Monday to Friday

[www.electriQ.co.uk](http://www.electriQ.co.uk)

Unit J6, Lowfields Business Park  
Lowfields Way, Elland  
West Yorkshire, HX5 9DA

## TECHNICAL DATA

Model	CMAC20M
Cooling capacity:	18,000 BTU
Input power:	2200 W
Fan	AC motor with 2 fan speeds.
Maximum Air flow volume:	740m <sup>3</sup> /h
Input current:	10 A
Refrigerant:	R1234yf/950g
Thermostat:	15 - 35°C
Maximum working pressure of suction/exhaust side:	1.0/2.5 MPa
Maximum Allowable Pressure	2.5 Mpa
Power Supply:	AC 220-240V/50 Hz
Net Weight:	95 kg
Dimension(L*D*H):	625 x 560 x 1135 mm
Unit must be vented outside when in Air Cooling mode. For the purposes of EU regulation EN12102 this is a local air conditioner and produces less than 65dB(A) sound energy.	
